

JOVA TRADE s.r.o.

viazacie prostriedky | zdvíhacia technika

Južná trieda 48, 040 01 Košice

mobil: 0910 981 041 | e-mail: obchod@jovatrade.sk



www.jovatrade.sk

2



Viazacie reťaze na zdvíhanie

Viazacie reťaze

- trieda 8
- trieda 10
- trieda 12
- nerez G6 plus INOX



Textilné viazacie prostriedky

Textilné viazacie prostriedky

- popruhy (pásy) EN 1492 1
- nekonečné slučky EN 1492 2
- textilné závesy ukončené hákmi
- upínacie popruhy (pásy) s račňou
- ochrany viazacích prostriedkov



Zdvíhacie zariadenia

Zdvíhacie zariadenia Yale PFAFF

- kladkostroje
- zdviháky
- navijáky
- rehtačkové, reťazové, lanové,
- hrebeňové, hydraulické



Zvierky na manipuláciu s materiálom

Zvierky na manipuláciu s materiálom

- Terrier, Tigrip, Crosby iP
- vertikálne, horizontálne
- skrutkovacie
- na skruze a rúry
- špeciálne



Prostriedky na práce vo výškach

Prostriedky na práce vo výškach

- postroje
- laná na istenie
- tlmiče pádu
- kotviaci a istiaci systém
- karabíny, laná, háky



Stohovacie háky

Stohovacie háky

- prenášanie tabúl a zväzkov plechov
- Pewag GHW, BWW
- Tigrip BVH



Reťaze na kotvenie bremena

Súpravy na upevňovanie bremena na vozidlách

- račňové napínače a reťaze trieda 8
- račňové napínače a reťaze trieda 10



Viazacie body

Viazacie body

- skrutky s okom
- otočné a sklopné
- navarovacie oká



Navarovacie viazacie body

Navarovacie oká

- PLE pewag



Ocelové laná

Ocelové laná

- rôzne prevedenia
- metráž

Obsah

Textilné viazacie prostriedky

Popruhy s okami	4
Nekonečné slučky	4-5
Závesy a ochrany	6-7
Upínacie popruhy	8



Viazacie reťaze

Trieda G8, G10	9-11
Trieda G12, G6 plus nerez	12
Prevedenia reťazí pewag G10	13-14
Reťaze na kotvenie	15



Komponenty reťazí

Komponenty trieda G8	16-17
Komponenty trieda G10	18-19



Viazacie body

Skrutky s okom trieda G10, G8	20
Navarovacie oká, háky G10, G8	21
Strmene	22-23



Zvierky na zdvíhanie

Vertikálne	24-26
Horizontálne	26-27
Skrutkovacie	27
Špeciálne pre sudy, rúry atd.	28-29
Zvierky na skruže	28-29
Stohovacie háky	28-29
Traverzy, závesy pre VZV	28-29



Zdvíhacie zariadenia

Ručné reťazové kladkostroje	30
Pojazdy	30
Rechtačkové zdviháky	31
Lanové zdviháky	31
Hrebeňové zdviháky	31
El.kladkostroje, navijáky	31



Magnety

Bremenové magnety	32
-------------------	----



Váhy

Závesné váhy	33
Postroje na práce vo výškach	33



Oceľové laná

Tabuľka nosností oceľ. lán	34
----------------------------	----



Textilné viazacie prostriedky

Viazacie popruhy a slučky vyrobené z materiálu polyester PES .

Viazací popruh typ B2

Štandardný dvojvrstvový popruh s okami (EN 1492-1)



Označenie	Nosnosť (kg)	Šírka (mm)	Farba
B2 - 1	1 000	30	Fialová
B2 - 2	2 000	60	Zelená
B2 - 3	3 000	90	Žltá
B2 - 4	4 000	120	Sivá
B2 - 5	5 000	150	Červená
B2 - 6	6 000	180	Hnedá
B2 - 8	8 000	240	Modrá
B2- 10	10 000	300	Oranžová

Vyššie nosnosti na požiadanie.

Nekonečná viazacia slučka typ RS

Štandardná vinutá slučka (EN 1492-2)



Označenie	Nosnosť (kg)	Farba
RS 1	1 000	Fialová
RS 2	2 000	Zelená
RS 3	3 000	Žltá
RS 4	4 000	Sivá
RS 5	5 000	Červená
RS 6	6 000	Hnedá
RS 8	8 000	Modrá
RS 10	10 000	Oranžová
RS 12	12 000	Oranžová
RS 15	15 000	Oranžová
RS 20	20 000	Oranžová
RS 25	25 000	Oranžová

Viazací popruh typ B4 – 4 vrstvový (EN 1492-1)

Dvojnásobná nosnosť oproti dvojvrstvovému rovnakej šírky.

Viazací popruh typ Cr2 (EN 1492-1)

Použitie s oceľovými okami ED alebo EZD

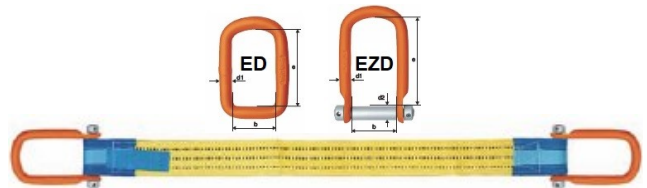

Označenie	Nosnosť (kg)	Šírka (mm)	Farba
B4 - 2	2 000	30	Fialová
B4 - 4	4 000	60	Zelená
B4 - 6	6 000	90	Žltá
B4 - 8	8 000	120	Sivá
B4 - 10	10 000	150	Oranžová
B4 - 12	12 000	180	Oranžová
B4 - 16	16 000	240	Oranžová
B4 - 20	20 000	300	Oranžová

Označenie	Nosnosť (kg)	Šírka (mm)	Farba
Cr2 - 1000	1 000	30	Fialová
Cr2 - 2000	2 000	60	Zelená
Cr2 - 3000	3 000	90	Žltá
Cr2 - 4000	4 000	120	Sivá
Cr2 - 5000	5 000	150	Červená
Cr2 - 6000	6 000	180	Hnedá
Cr2 - 8000	8 000	240	Modrá

V objednávke uveďte požadované oká ED alebo EZD.

Textilné viazacie prostriedky

Nekonečná viazacia slučka **RS PRO**

Zosilnený obal slučky. EN 1492-2)



Nekonečný popruh **typ A2**

Vyrobený z tkaného popruhu. (EN 1492-2)



Označenie	Nosnosť (kg)	Farba	Označenie	Nosnosť (kg)	Šírka (mm)	Farba
RS PRO 1	1 000	Fialová	A2 - 1	1000	30	Fialová
RS PRO 2	2 000	Zelená	A2 - 2	2000	60	Zelená
RS PRO 3	3 000	Žltá	A2 - 3	3000	90	Žltá
RS PRO 4	4 000	Sivá	A2 - 4	4000	120	Sivá
RS PRO 6	6 000	Hnedá	A2 - 5	5000	150	Červená
RS PRO 8	8 000	Modrá	A2 - 6	6000	180	Hnedá
RS PRO 10	10 000	Oranžová	A2 - 8	8000	240	Modrá
RS PRO 12	12 000	Oranžová	Možnosť dodania s dvojnásobnou nosnosťou a rovnakou šírkou s označením typ A4			
RS PRO15	15 000	Oranžová				



Jednorázové viazacie slučky

Vyrobené z tkaného popruhu pre jednorázové zdvíhanie tovaru.

Až 7 násobný bezpečnostný faktor v súlade s EN 1492-1 (modrý štítok)

5 násobný bezpečnostný faktor v súlade s DIN 60005 (oranžový štítok)



V súlade s EN 1492-1 (bezpečnostný faktor 7:1)				V súlade s DIN 60005 (bezpečnostný faktor 5:1)			
Označenie	Dĺžka (m)	Nosnosť (kg)	Šírka (mm)	Označenie	Dĺžka (m)	Nosnosť (kg)	Šírka (mm)
Typ A48 x 2000 / 500	2,00	500	48	Typ A 48 x 500 / 750	0,50	750	48
Typ A50 x 500 / 500	0,50	500	50	Typ A 48 x 700 / 750	0,70	750	48
Typ A50 x 500 /1000	0,50	1000	50	Typ A 50 x 800 / 2500	0,80	2500	50
Typ A50 x 800 /1000	0,80	1000	50	Typ A 50 x 1000 / 2500	1,00	2500	50
Typ A50 x 1000 /1000	1,00	1000	50	Typ A 50 x 1300 / 2500	1,30	2500	50

Ideálne pre jednorázový transport od výrobcu ku konečnému spotrebiteľovi.

Jednorázové viazacie slučky nemôžu byť používané opakovane, po použití musia byť zničené.

Textilné viazacie prostriedky

Závesy z textilných viazacích popruhov B2 a slučiek RS (EN 1492-2)

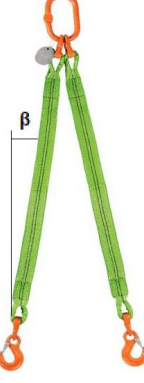
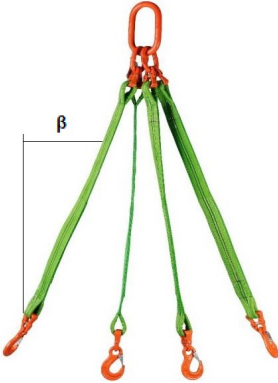
	1 ramenné	2 ramenné	3 a 4 ramenné	
Popruh B2				Slučka RS

Tabuľka nosností (kg) v závislosti od uhla sklonu ramien závesu.

uhol sklonu ramena β		0° - 45°	45° - 60°	0° - 45°	45° - 60°	
Popruh B2 / šírka	kg	kg	kg	kg	kg	Slučka RS
B2 – 1 / 30 mm	1000	1400	1000	2100	1500	RS 1
B2 – 2 / 60 mm	2000	2800	2000	4200	3000	RS 2
B2 – 3 / 90 mm	3000	4200	3000	6300	4500	RS 3
B2 – 4 / 120 mm	4000	5600	4000	8400	6000	RS 4

Možnosť voľby výroby závesov z popruhov B2 alebo slučiek RS.
Vyššie nosnosti na požiadanie.

Ochrany popruhov a slučiek

AS pogumovaná ochrana proti oderu určená pre bremená s drsným povrchom

Použitie pre popruhy a slučky.

Pri objednaní uveďte typ popruhu alebo slučky, pre ktoré ochranu požadujete a dĺžku ochrany.



GS trojvrstvá efektívna ochrana vyrobená z polyesterových popruhov

Štandardná dĺžka 500 mm (iné dĺžky na vyžiadanie)

Pri objednaní uveďte typ popruhu alebo slučky pre ktoré ochranu požadujete.

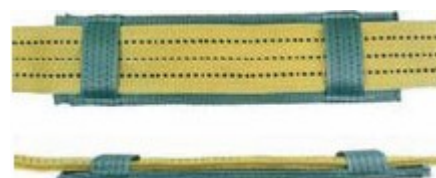

Textilné viazacie prostriedky

Ochrany popruhov a slučiek

PU polyuretánová ochrana – vysoká odolnosť voči ostrým hranám

typ **PU-1** použitie z jednej strany

typ **PU-2** použitie z oboch strán

typ **PU-O** otvorená (možnosť navlečenia z boku viazacieho prostriedku)

Použitie z jednej strany pre popruhy a slučky

Pri objednaní uveďte typ popruhu alebo slučky pre ktorý ochranu požadujete a dĺžku ochrany.

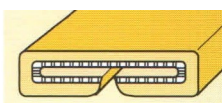
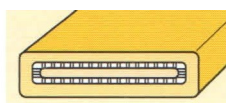
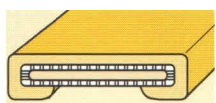

PU-1 jednostranná

PU-2 dvojstranná

PU-O otvorená

Typy navlečenia ochrán na popruhy a nekonečné slučky.

Typ navlečenia 1 a 2 pre popruhy a typ navlečenia 3 až 6 pre nekonečné slučky



typ 1

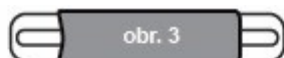

typ 3

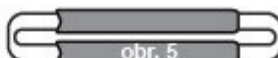

typ 5



typ 2



typ 4



typ 6

PU rohová polyuretánová ochrana

typ **PU-R** bez magnetov

typ **PU-R+M** vybavená magnetmi

Pri objednaní uveďte typ popruhu alebo slučky, pre ktoré ochranu požadujete.

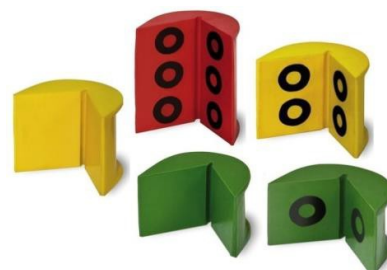

Hák HBH pre textilné viazacie prostriedky.

Pre jednoduché priame spojenie s nekonečnými slučkami a popruhmi. Vďaka tomuto háku je možné vytvorenie 1 – 4 ramenných závesných viazacích prostriedkov. Všetky háky s kovanými bezpečnostnými poistkami.



Textilné viazacie prostriedky

Upínacie popruhy EN 12195-2

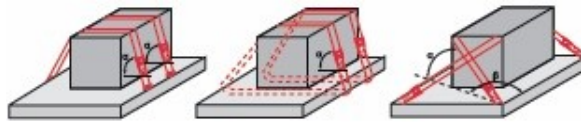

Dvojdielne upínacie popruhy

Označenie	Šírka popruhu (mm)	Prípustná ťažná sila LC daN	
UP 2- 25 - 500	25	500 daN	250 daN
UP 2- 35 - 2000	35	2 000 daN	1 000 daN
UP 2- 50 - 4000	50	4 000 daN	2 000 daN
UP 2- 50 - 5000	50	5 000 daN	2 500 daN
UP 2- 75 – 10 000	75	10 000 daN	5 000 daN
UP 2- 75 KV (háky DHS)	75	-	10 000 daN



V štandardnom dvojdielnom prevedení sú dodávané s klasickou račňou a hákmi typ RH100 . ➡ 

V ponuke aj popruhy s ERGO račňou.

Jednodielne upínacie popruhy

Označenie	Šírka popruhu (mm)	Prípustná ťažná sila LC daN
UP 1- 25 - 500	25	500 daN
UP 1- 35 - 2000	35	2 000 daN
UP 1- 50 - 4000	50	4 000 daN
UP 1- 50 - 5000	50	5 000 daN
UP 1- 75 – 10 000	75	10 000 daN



V štandardnom jednodielnom prevedení sú dodávané s klasickou račňou.

Ochrany upínacích popruhov

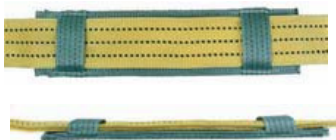

GS (mat. 3.vrstvový popruh)



KSPAD (plast)



KSM (kov)



KSP (plast)



KSSCH (plast)

Typy ukončení popruhov na požiadanie.



RH 100



DHS 100



RHS 100



D 100



FPH 100



KHF 100



FH 100



T 100



KHG 100

Viazacie ret'aze

Viazacie ret'aze EN 818 EN 1677.

- prevedenia 1- 2 - 3 - 4 ramenné , nekonečné slučky
- ukončené hákmi so západkou
- dostupné aj s alternatívnym ukončením, napríklad s okami
- označené identifikačným štítkom s vyznačenou nosnosťou a výrobným číslom
- bezpečnostný faktor 4 : 1
- dodávané s certifikátom a návodom na použitie
- servis - vykonávanie odborných prehliadok a záťažových skúšok

Pevnostná trieda G8 štandardné ret'aze

Pevnostná trieda G10 o 25% vyššia nosnosť ako G8

Pevnostná trieda G12 o 50 % vyššia nosnosť ako G8 o 20% ako G10

Nerezové pevnostná trieda inox G6 plus využitie antikoročných vlastností



1 - 2 - 3 - 4 ramenné prevedenia

Viazacie reťaze

Viazacie reťaze môžu byť vybavené skracovacími hákmi pomocou ktorých môžete skrátiť dĺžku ramien viazacej reťaze.



Príklad objednávky viazacej reťaze :

označenie prevedenia : 10 x 2000 tr.8 / oko - 4 hák

označenie prevedenia so skracovačmi : 10 x 2000 tr.8 / oko - 4 hák + 4 skracovače

10 - hrúbka reťaze (\varnothing mm)

2000 - požadovaná dĺžka **L** (mm) sa udáva

vrátane závesného oka a hákov ako je označená na obrázku č.1 a č.2 .

tr. 8 - požadovaná pevnostná trieda

oko - závesná časť

4 hák - počet ramien / koncová časť

+ 4 skracovače - počet skracovačov

Nosnosť viazacích reťazí príslušnej pevnostnej triedy a hrúbky nájdete v tabuľkách.

oko – 2 hák+ 2 skracovače

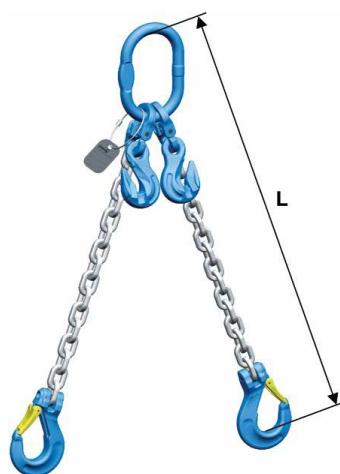

č.1





oko – 4 hák



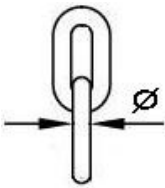

č.2

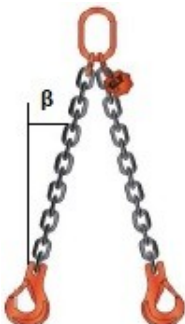

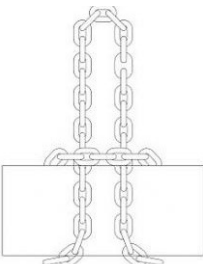

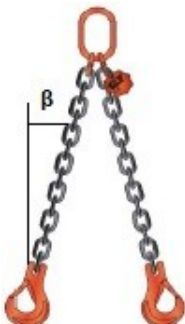
L= objednávacia dĺžka (mm)

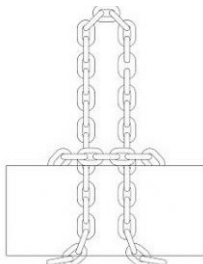

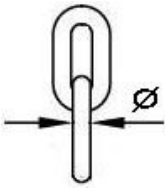

Viazacie ret'aze

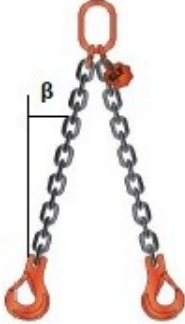
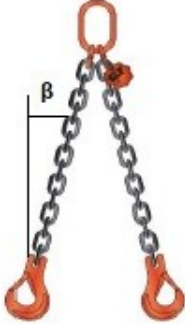
		Pevnostná trieda G8			Nosnosti kg	
	1 ramenné	2 ramenné		3 a 4 ramenné		Nekonečné slučky
						
uhol sklonu β		β 0° - 45°	β 45° - 60°	β 0° - 45°	β 45° - 60°	
Ø ret'aze (mm)	kg	kg	kg	kg	kg	kg
Ø 6	1 120	1 600	1 120	2 360	1 700	1 800
Ø 8	2 000	2 800	2 000	4 250	3 000	3 150
Ø 10	3 150	4 250	3 150	6 700	4 750	5 000
Ø 13	5 300	7 500	5 300	11 200	8 000	8 500
Ø 16	8 000	11 200	8 000	17 000	11 800	12 500
Ø 19	11 200	16 000	11 200	23 600	17 000	18 000
Ø 22	15 000	21 200	15 000	31 500	22 400	23 600
Ø 26	21 200	30 000	21 200	45 000	31 500	33 500
Ø 32	31 500	45 000	31 500	67 000	47 500	50 000

		Pevnostná trieda G10			Nosnosti kg	
	1 ramenné	2 ramenné		3 a 4 ramenné		Nekonečné slučky
						
uhol sklonu β		β 0° - 45°	β 45° - 60°	β 0° - 45°	β 45° - 60°	
Ø ret'aze (mm)	kg	kg	kg	kg	kg	kg
Ø 6	1 400	2 000	1 400	3 000	2 120	2 240
Ø 8	2 500	3 550	2 500	5 300	3 750	4 000
Ø 10	4 000	5 600	4 000	8 000	6 000	6 300
Ø 13	6 700	9 500	6 700	14 000	10 000	10 600
Ø 16	10 000	14 000	10 000	21 200	15 000	16 000
Ø 19	14 000	20 000	14 000	30 000	21 200	22 400
Ø 22	19 000	26 500	19 000	40 000	28 000	30 000
Ø 26	26 500	37 500	26 500	56 000	40 000	42 500
Ø 32	40 000	56 000	40 000	85 000	60 000	63 000

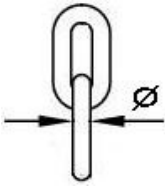
Viazacie reťaze

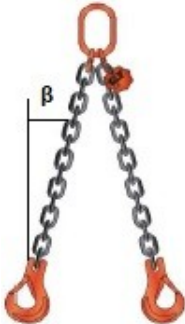
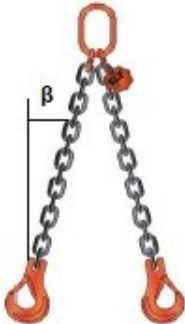
Pevnostná trieda G12				Nosnosti kg		
	1 ramenné	2 ramenné		3 a 4 ramenné		Nekonečné slučky
						
uhol sklonu β		β 0° - 45°	β 45° - 60°	β 0° - 45°	β 45° - 60°	
Ø reťaze (mm)	kg	kg	kg	kg	kg	kg
Ø 7	2 360	3 350	2 360	5 000	3 550	3 750
Ø 8	3 000	4 250	3 000	6 300	4 500	4 750
Ø 10	5 000	7 100	5 000	10 600	7 500	8 000
Ø 13	8 000	11 200	8 000	17 000	11 800	12 500
Ø 16	12 500	17 500	12 500	26 500	19 000	20 000

Nerezové pevnostná trieda G6 plus				Nosnosti kg		
	1 ramenné	2 ramenné		3 a 4 ramenné		Nekonečné slučky
						
uhol sklonu β		β 0° - 45°	β 45° - 60°	β 0° - 45°	β 45° - 60°	
Ø reťaze (mm)	kg	kg	kg	kg	kg	kg
Ø 5	630	850	630	1 300	940	1 000
Ø 7	1 250	1 750	1 250	2 600	1 850	2 000
Ø 10	2 500	3 500	2 500	5 250	3 750	4 000
Ø 13	4 250	5 950	4 250	8 900	6 350	6 800
Ø 16	6 300	8 800	6 300	13 200	9 400	10 000

Prevedenia viazacích ret'azí

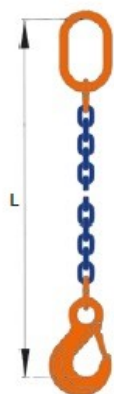

I AW-HSW Connex

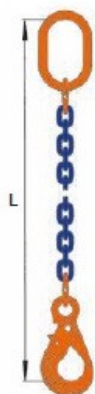

I AW-LHW Connex

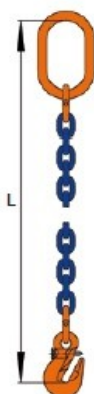

I AW-PSW Connex

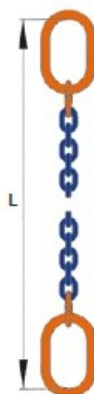

I AW-AW Connex

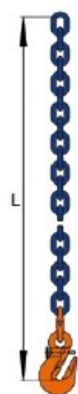

I PSW Connex

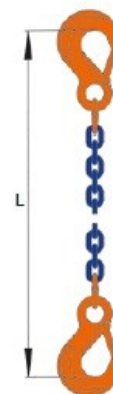

I HSW-HSW Connex

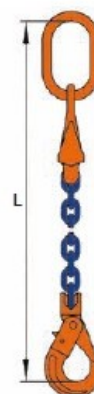

I VXKW-KLHW

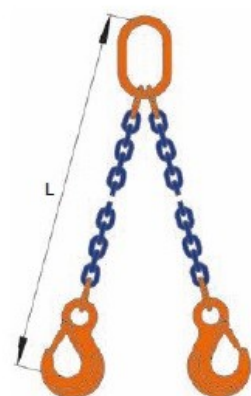

II AW-HSW Connex

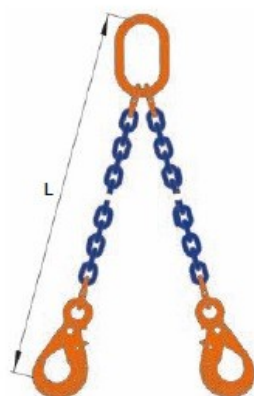

II AW-LHW Connex

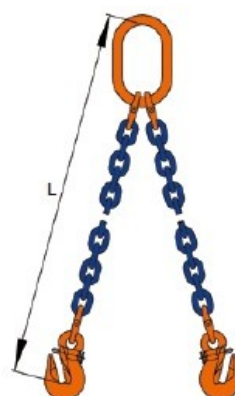

II AW-PSW Connex

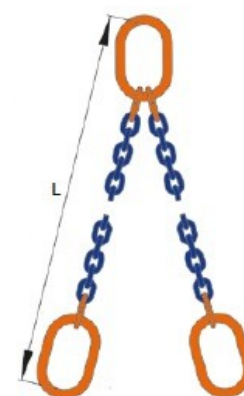

II AW-AW Connex

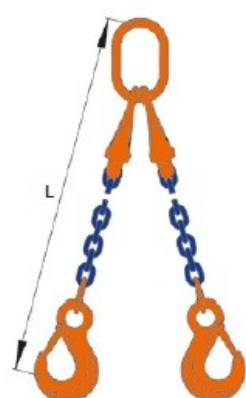

II VXKW-HSW Connex

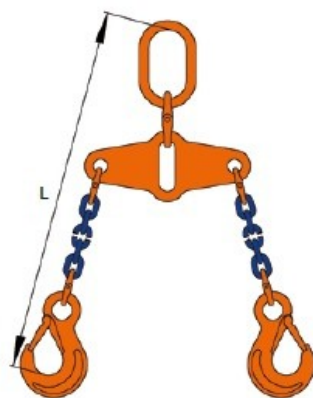

II AW-HSW-AGWW Connex

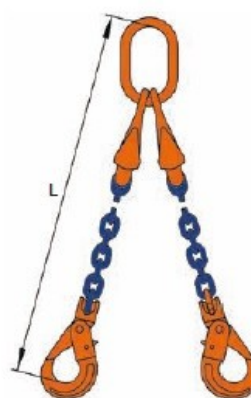

II VXKW-KLHW

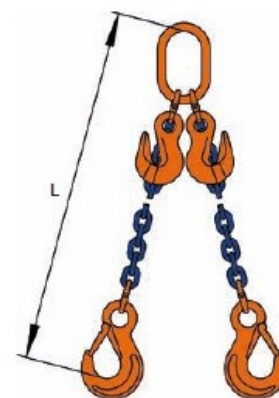

II AW-HSW-PW Connex

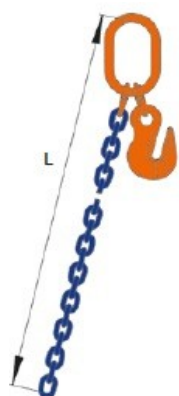

II AW-S-PW Connex



III VW-HSW Connex



III VW-LHW Connex

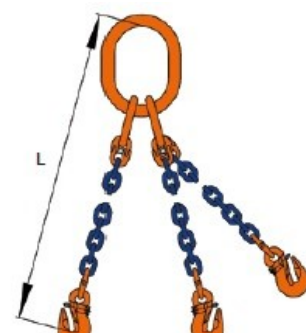

III VW-PSW Connex



III VW-AW Connex

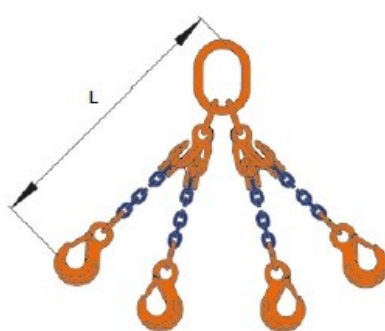

IV VXXW-HSW Connex



IV VW-HSW-AGWW Connex

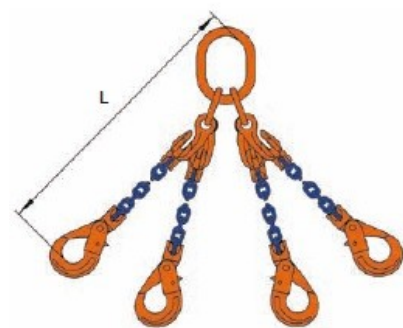

IV VXXW-KLHW

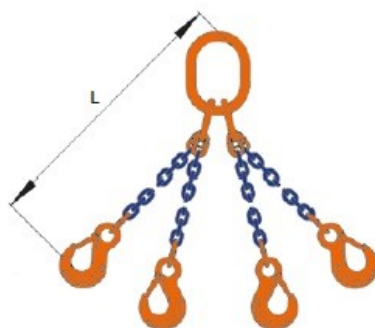

IV VW-HSW Connex

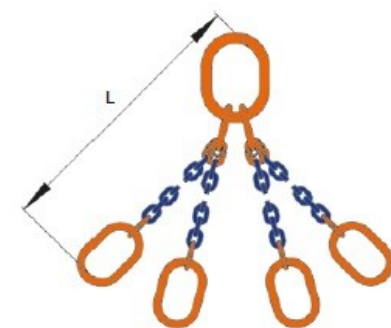

IV VW-AW Connex

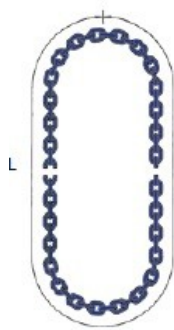

S

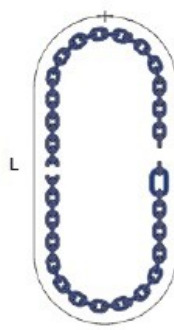

SK (od průměru 8!)



II AW-S Connex



IV VW-S Connex

Reťaze na kotvenie

Dvojdielny systém trieda **G8-G10-G12**

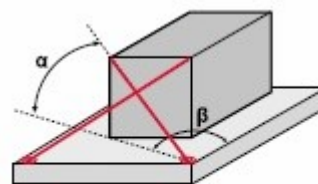

Račňový napínak reťaze trieda G8				Reťaz pre račňový napínak trieda G8		
Označenie	Prípustná ťažná sila LC (kN)	Štandardná sila predpätia (daN)	Použitie s reťazou G8 Ø (mm)	Označenie	Prípustná ťažná sila LC (kN)	Reťaz G8 Ø (mm)
RSPS 8	40	1900	8	ZK 8-G8	40	8
RSPS 10	63	1900	10	ZK 10-G8	63	10
RSPS 13	100	3000	13	ZK 13-G8	100	13







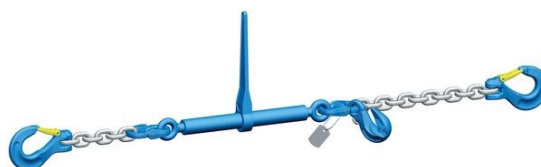



Račňový napínak reťaze trieda G10				Reťaz pre račňový napínak trieda G10		
Označenie	Prípustná ťažná sila LC (kN)	Štandardná sila predpätia (daN)	Použitie s reťazou G10 Ø (mm)	Označenie	Prípustná ťažná sila LC (kN)	Reťaz G10 Ø (mm)
RSPSW 8	50	1900	8	ZKW 8-G10	50	8
RSPSW 10	80	3000	10	ZKW 10-G10	80	10
RSPSW 13	134	2500	13	ZKW 13-G10	134	13

Račňový napínak reťaze trieda G12				Reťaz pre račňový napínak trieda G12		
Označenie	Prípustná ťažná sila LC (kN)	Štandardná sila predpätia (daN)	Použitie s reťazou G12 Ø (mm)	Označenie	Prípustná ťažná sila LC (kN)	Reťaz G12 Ø (mm)
RSPSWP 7	47	1900	7	ZKWP 7-G12	47	7
RSPSWP 8	60	1900	8	ZKWP 8-G12	60	8
RSPSWP 10	100	3000	10	ZKWP10-G12	100	10
RSPSWP 13	160	2500	13	ZKWP13-G12	160	13

V ponuke aj jednodielny systém **ZRS G8 - ZRSW G10 - ZRSWP G12**



Komponenty viazacích reťazí triedy G8

Oko G8		Hlava G8		Spojka G8		Hák s vidlicou G8		Hák s okom G8		Hák samozverný s vidlicou G8	
											
Veľkosť (mm)	Nosnosť (t)	Veľkosť (mm)	Nosnosť (t)	Veľkosť (mm)	Nosnosť (t)	Veľkosť (mm)	Nosnosť (t)	Veľkosť (mm)	Nosnosť (t)	Veľkosť (mm)	Nosnosť (t)
7/6	1,6	6	2,36	6	1,12	6	1,12	6	1,12	6	1,12
8/7	2,12	8	4,25	8	2	8	2	8	2	8	2
10/8	3,15	10	6,7	10	3,15	10	3,15	10	3,15	10	3,15
13/10	5,3	13	11,2	13	5,3	13	5,3	13	5,3	13	5,3
16/13	8	P 16	19,7	16	8	16	8	16	8	16	8
P 18/16	11,8	P 18	30,7	20	12,5	20	12,5	18+20	12,5		
P 20/18	25,1	P 20	34,1	22	15	22	15	22	15		
P 22/20	25,1	P 22	40	26	21,2			26	21,2		
P 26/22	30,8	P 26	54	32	31,5			32	31,5		
P 32/26	40	P 32	76								
Hák samozverný s okom G8		Hák samozverný otočný s okom G8		Hák zlievarenský G8		Skracovací hák s vidlicou G8		Skracovací hák s okom G8		Článková reťaz G8	
											
Veľkosť (mm)	Nosnosť (t)	Veľkosť (mm)	Nosnosť (t)	Veľkosť (mm)	Nosnosť (t)	Veľkosť (mm)	Nosnosť (t)	Veľkosť (mm)	Nosnosť (t)	Veľkosť (mm)	Nosnosť (t)
6	1,12	6	1,12	7+8	2	6	1,12	6	1,12	6	1,12
8	2	8	2	10	3,15	8	2	8	2	7	1,5
10	3,15	10	3,15	13	5,3	10	3,15	10	3,15	8	2
13	5,3	13	5,3	16	8	13	5,3	13	5,3	10	3,15
16	8	16	8	18+20	12,5	16	8	16	8	13	5,3
18+20	12,5			22	15	20	12,5	18+20	12,5	16	8
22	15			26	21,2	22	15	22	15	18	10
				32	31,5			26	21,2	20	12,5
								32	31,5	22	15
										26	21,2
										32	31,5

Komponenty viazacích reťazí triedy G8

Poistka háku s vidlicou a okom G8		Poistka pre hák výklopný G8		Strmeň Unilock-U G8		Segment otočný pod záťažou G8		S – hák G8		Hák pre transport balíkov G8	
Veľkosť (mm)		Veľkosť (mm)		Veľkosť (mm)	Nosnosť (kg)	Veľkosť (mm)	Nosnosť (kg)	Veľkosť (mm)	Nosnosť (kg)	Veľkosť (mm)	Nosnosť (kg)
6		6		U 5/6	1.120	DF 5/6	1.120	SM 5	800	BA 5/6	1.120
8		8		U 7	1.500	DF 7/8	2.000	SM 7/8	2000	BA 7/8	2.000
10		10		U 8	2.000	DF 10	3.150	SM 10	3.150	BA 10	3.150
13		13		U 10	3.150	DF 13	5.300	SM 13	5.300		
16		16		U 13	5.300			SM 16	8.000		
18+20		18+20		U 16	8.000			SM 19	11.200		
22		22		U 19/20	12.500						
26				U 26	21.200						
32											
Napínací zámok reťaze G8		Hák sudový G8		Kliešte samozverné G8		Identifikačný štítok reťaze G8		Štítok pre reťaze na kotvenie			
Typ	Nosnosť (kg)	Typ	Nosnosť (kg)	Typ	Nosnosť (kg)	Rozsah (mm)	Jedno ramenné	Viac ramenné			
KSS 7	1.500	FA 5/6	500	HZ 0,125	125	100-200					
KSS 8	2.000			HZ 0,25	250	130-300					
KSS 10	3.150			HZ 0,5	500	160-400					
KSS 13	5.300			HZ 1	1.000	215-500					
KSSW 16	10.000			HZ 2	2.000	250-600					

oko AW	oko MW	súprava VW	súprava VMW	prechod. čl. BW	súprava VAW
súprava VLW 1	súprava VLW 2/4	súprava VSW 2/4	oko VSAW 1	súprava VSAW 2	súprava KAGW 1
súprava KAGW 2	súprava KAGW 4	súprava KMGW 1	súprava KMGW 2	súprava KMGW 4	súprava VXKW 1
súprava VXKW 2	súprava VXKW 4	súprava MXKW 1	súprava VMXKW 2	súprava VMXKW 4	súprava LXKW 1
súprava LXKW 2	súprava LXKW 4	spojka CW	spojka CLW	spojka CARW	hák KHSW
hák BKHSW	hák HSW	hák KLHW	hák LHW	hák WLHW	hák WLHBW

Viac info na www.jovatrade.sk

háč WSBW	háč KFW	háč FW	háč KPW	háč PW	háč KPSW
háč PSW	háč XKW	háč BWW	háč GHW	strmeň GSCHW	strmeň SCHW
kolík na skruže	spojka KRW	oko KOW	vahadlo AGWW	háč KCHW	strmeň KSCHW
navarovací háč AWHW	prechodový záves UW 1	prechodový záves UW 2	reťaz WIN. 200 G10	reťaz WIN. 400 G10	poistka SFGHW
poistka VLHW	poistka PSGW	štítok G10	štítok G10- nerez		

Viac info na www.jovatrade.sk

Viazacie body

Viazacie body - skrutky s okom trieda G10 / G8



PLDW	Označenie	Závit (mm)	Nosnosť (kg)	PLBW	Označenie	Závit (mm)	Nosnosť (kg)	
	PLDW 0,3 t	M8 x 1,25	300		PLBW 0,3 t	M8 x 1,25	300	
	PLDW 0,5 t	M10 x 1,5	500		PLBW 0,6 t	M10 x 1,5	600	
	PLDW 0,7 t	M12 x 1,75	700		PLBW 1 t	M12 x 1,75	1 000	
	PLDW 1 t	M14 x 2	1 000		PLBW 1,3 t	M14 x 2	1 300	
	PLDW 1,5 t	M16 x 2	1 500		PLBW 1,6 t	M16 x 2	1 600	
	PLDW 2,5 t	M20 x 2,5	2 500		PLBW 2 t	M18 x 2,5	2 000	
	PLDW 4 t	M24 x 3	4 000		PLBW 2,5 t	M20 x 2,5	2 500	
	PLDW 6 t	M30 x 3,5	6 000		PLBW 3 t	M22 x 2,5	3 000	
	PLDW 8 t	M36 x 4	8 000		PLBW 4 t	M24 x 3	4 000	
	PLDW 10 t	M42 x 4,5	10 000		PLBW 5 t	M27 x 3	5 000	
	PLDW 12,5 t	M48 x 5	12 500		PLBW 6,3 t	M30 x 3,5	6 300	
						PLBW 8 t	M33 x 3,5	8 000
					PLBW 10 t	M36 x 4	10 000	
					PLBW 12,5 t	M42 x 4,5	12 500	
					PLBW 15 t	M48 x 5	15 000	
PLAW	Označenie	Závit (mm)	Nosnosť (kg)	AOR	Označenie	Závit (mm)	Nosnosť (kg)	
	PLAW 0,3	M8 x 1,25	300		AOR 10	M16 x 2	3 150	
	PLAW 0,63	M10 x 1,5	630		AOR 13	M20 x 2,5	5 300	
	PLAW 1 t	M12 x 1,75	1 000		AOR 16	M30 x 3,5	8 000	
	PLAW 1,5 t	M16 x 2	1 500		AOR 22	M36 x 4	15 000	
	PLAW 2,5 t	M20 x 2,5	2 500		AOR 26	M42 x 4,5	21 200	
	PLAW 4 t	M24 x 3	4 000		AOR 28	M45 x 4,5	25 000	
	PLAW 6 t	M30 x 3,5	6 000		AOR 32	M56 x 5,5	31 500	
	PLAW 7 t	M36 x 4	7 000		AOR 34	M56 x 5,5	36 000	
	PLAW 8 t	M36 x 4	8 000					
	PLAW 10 t	M42 x 4,5	10 000					
	PLAW 15 t	M42 x 4,5	15 000					
	PLAW 20 t	M48 x 5	20 000					
PLGW	Označenie	Závit (mm)	Nosnosť (kg)	RGS	Označenie	Závit (mm)	Nosnosť (kg)	
Dostupné aj v nerezovom prevedení (PLGWI) 	PLGW 0,3 t	M8 x 1,25	300		RGS 8	M8 x 1,25	400	
	PLGW 0,5 t	M10 x 1,5	500		RGS 10	M10 x 1,5	700	
	PLGW 0,7 t	M12 x 1,75	700		RGS 12	M12 x 1,75	1 000	
	PLGW 1,5 t	M16 x 2	1 500		RGS 14	M14 x 2	1 200	
	PLGW 2,3 t	M20 x 2,5	2 300		RGS 16	M16 x 2	1 500	
	PLGW 2 t inox	M20 x 2,5	2 000		RGS 20	M20 x 2,5	2 500	
	PLGW 3,2 t	M24 x 3	3 200		RGS 24	M24 x 3	4 000	
	PLGW 4 t	M30 x 3,5	4 000					
	PLGW 4,9 t	M30 x 3,5	4 900					
	PLGW 7 t	M36 x 4	7 000					
	PLGW 9 t	M42 x 4,5	9 000					
	PLGW 12 t	M48 x 5	12 000					
PLGW-SN	Označenie	Závit (mm)	Nosnosť (kg)	APD SR	Závit	Nosnosť	Závit	Nosnosť
	PLGW-SN 0,3 t	M 8 x 1,25	300		M 8	300	M 18	1 600
	PLGW-SN 0,5 t	M10 x 1,5	500		M 10	600	M 20	2 500
	PLGW-SN 0,7 t	M12 x 1,75	700		M 12	1 000	M 22	2 500
	PLGW-SN 1,5 t	M16 x 2	1 500		M 14	1 000	M 24	4 000
	PLGW-SN 2,3 t	M20 x 2,5	2 300		M 16	1 600	M 30	6 300
	PLGW-SN 3,5 t	M24 x 3	3 500					
	PLGW-SN 4,9 t	M30 x 3,5	4 900					
				APD SS	Závit	Nosnosť (kg)		
					M 36	10 000		
					M 42	12 500		
					M 48	20 000		
					M 56	25 000		
					M 64	32 100		

Viazacie body - navarovacie oká a háky trieda G8 / G10

trieda G8

trieda G10

PLE/N (navarovacie oko)	Označenie	Nosnosť (kg)	PLEW (navarovacie oko)	Označenie	Nosnosť (kg)
	PLE/N 6	1 120		PLEW 1,5	1 500
	PLE/N 8	2 000		PLEW 2,5	2 500
	PLE/N 10	3 150		PLEW 4	4 000
	PLE/N 13	5 300		PLEW 6,7	6 700
	PLE/N 16	8 000		PLEW 10	10 000
	PLE/N 22	15 000		PLEW 19	19 000
HAS (navarovací hák)	Označenie	Nosnosť (kg)	AWHW (navarovací hák)	Označenie	Nosnosť (kg)
	HAS 1,3	1 300		AWHW 1,3	1 300
	HAS 3,8	3 800		AWHW 3,8	3 800
	HAS 6,3	6 300		AWHW 6,3	6 300
	HAS 10	10 000		AWHW 10	10 000

Oko má integrovanú spružinu vďaka ktorej si zachová nastavenú polohu.

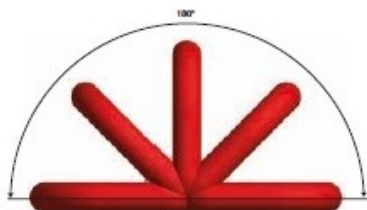

Obrázok 1



obrázok 2

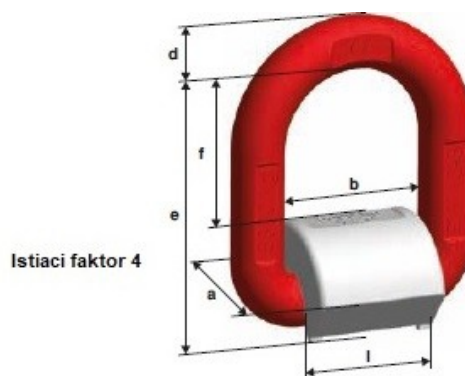

Istiaci faktor 4

Spôsob zavesenia
Počet ramien
Uhol sklonu

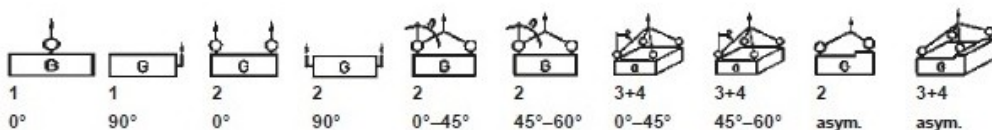

Označenie	Nosnosť [kg]	Nosnosť (kg)									
PLE/N 6	1.120	1.120	1.120	2.240	2.240	1.500	1.120	2.300	1.600	1.120	1.120
PLE/N 8	2.000	2.000	2.000	4.000	4.000	2.800	2.000	4.200	3.000	2.000	2.000
PLE/N 10	3.150	3.150	3.150	6.300	6.300	4.400	3.150	6.600	4.700	3.150	3.150
PLE/N 13	5.300	5.300	5.300	10.600	10.600	7.400	5.300	11.200	7.900	5.300	5.300
PLE/N 16	8.000	8.000	8.000	16.000	16.000	11.300	8.000	16.900	12.000	8.000	8.000
PLE/N 22	15.000	15.000	15.000	30.000	30.000	21.000	15.000	31.800	22.500	15.000	15.000

Istiaci faktor 4

Označenie	Nosnosť [kg]	a [mm]	b [mm]	d [mm]	e [mm]	f [mm]	l [mm]	Hmotnosť [kg/ks]
PLE/N 6	1.120	36	40	11	67	42	35	0,28
PLE/N 8	2.000	37	42	13	73	45	37	0,39
PLE/N 10	3.150	41	45	16,50	80	47	40	0,62
PLE/N 13	5.300	61	55	22	97	53	50	1,40
PLE/N 16	8.000	63	70	25	120	73	64	2,30
PLE/N 22	15.000	89	97	33	163	92	90	5,50

Strmene

Strmene trieda 6 EN 13889+A1

GM - SO

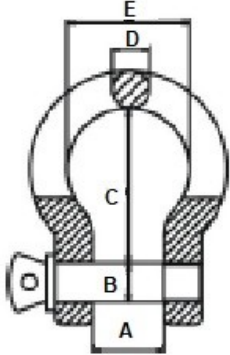
	Označenie	Nosnosť (ton.)	A	B	C	D	E	Hmotnosť kg / 1 kus	
	GM-SO 0,5	0,5	12,5	7,8	28,5	7	19,5	0,051	
	GM-SO 0,75	0,75	13	9,3	30	8,2	20,5	0,079	
	GM-SO 1	1	17	11	37,5	10	26,5	0,151	
	GM-SO 1,5	1,5	18	12,5	42,5	10,8	29	0,199	
	GM-SO 2	2	20,5	15,7	49	12,7	32,5	0,315	
	GM-SO 3,25	3,25	27	18,5	60	16	42,5	0,605	
	GM-SO 4,75	4,75	32,5	21,5	70,5	19,5	49,5	1,006	
	GM-SO 6,5	6,5	37,5	24,5	84,5	23	57,5	1,583	
	GM-SO 8,5	8,5	43	27,5	95	26	68	2,311	
	GM-SO 9,5	9,5	45	32	106	29	72,5	3,240	
	GM-SO 12	12	49	35	118	33	80	4,500	
	GM-SO 13,5	13,5	57	37,5	134	35	91	5,940	
GM-SO 17	17	62	41,5	149	38	98	7,760		

GM - SOZ

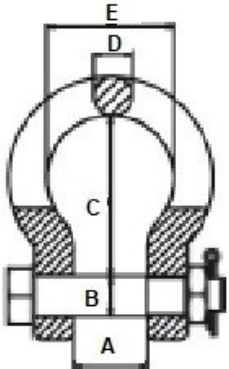
	Označenie	Nosnosť (ton.)	A	B	C	D	E	Hmotnosť kg / 1 kus	
	GM-SOZ 2	2	20,5	15,7	49	12,7	32,5	0,353	
	GM-SOZ 3,25	3,25	27	18,5	60	16	42,5	0,670	
	GM-SOZ 4,75	4,75	32,5	21,5	70,5	19,5	49,5	1,084	
	GM-SOZ 6,5	6,5	37,5	24,5	84,5	23	57,5	1,719	
	GM-SOZ 8,5	8,5	43	27,5	95	26	68	2,528	
	GM-SOZ 9,5	9,5	45	32	106	29	72,5	3,518	
	GM-SOZ 12	12	49	35	118	33	80	4,950	
	GM-SOZ 13,5	13,5	57	37,5	134	35	91	6,480	
GM-SOZ 17	17	62	41,5	149	38	98	8,420		

Strmene

Strmene trieda 6 EN 13889+A1

GM - SP

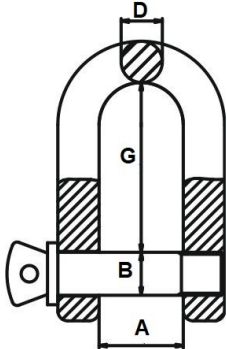
	Označenie	Nosnosť (ton.)	A	B	D	G	Hmotnosť kg / 1 kus	
	GM-SP 0,5	0,5	12	7,9	7,2	23	0,046	
	GM-SP 0,75	0,75	12,5	9,3	7,8	24,5	0,072	
	GM-SP 1	1	16,5	11	10	32	0,137	
	GM-SP 1,5	1,5	18	12,5	10,8	36,5	0,182	
	GM-SP 2	2	20	15,7	12,7	40,5	0,291	
	GM-SP 3,25	3,25	26	18,5	16	51	0,557	
	GM-SP 4,75	4,75	32,5	21,5	20	61	0,916	
	GM-SP 6,5	6,5	37	24,5	23,5	71,5	1,452	
	GM-SP 8,5	8,5	43	27,5	25	80	2,068	
	GM-SP 9,5	9,5	44,5	32	29	88	2,938	
	GM-SP 12	12	50	35	32	100	4,075	
	GM-SP 13,5	13,5	57,5	37,5	36	114	5,380	
GM-SP 17	17	60,5	41,5	39,5	123	7,096		

GM - SPZ

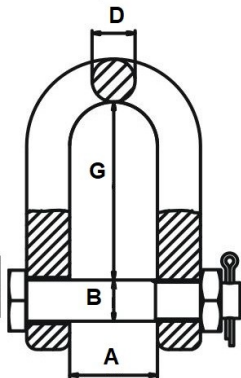
	Označenie	Nosnosť (ton.)	A	B	D	G	Hmotnosť kg / 1 kus	
	GM-SP 2	2	20	15,7	12,7	40,5	0,325	
	GM-SP 3,25	3,25	26	18,5	16	51	0,629	
	GM-SP 4,75	4,75	32,5	21,5	20	61	0,916	
	GM-SP 6,5	6,5	37	24,5	23,5	71,5	1,452	
	GM-SP 8,5	8,5	43	27,5	25	80	2,068	
	GM-SP 9,5	9,5	44,5	32	29	88	2,938	
	GM-SP 12	12	50	35	32	100	4,075	
GM-SP 13,5	13,5	57,5	37,5	36	114	5,380		
GM-SP 17	17	60,5	41,5	39,5	123	7,096		

Zdvíhacie zvierky

Vertikálne



VUW / VEUW / SVUW	Označenie	Nosnosť (kg)	Rozsah čelustí (mm)	VCW / VCEW / SVCW	Označenie	Nosnosť (kg)	Rozsah čelustí (mm)
	VUW 0,75 t	750	0 - 13		VCW 0,75 t	750	0 - 13
	VEUW 1 t	1 000	0 - 25		VCEW 1 t	1 000	0 - 25
	VEUW 2 t	2 000	0 - 35		VCEW 2 t	2 000	0 - 35
	VEUW 3 t	3 000	0 - 35		VCEW 3 t	3 000	0 - 35
	VUW 4,5 t	4 500	0 - 25		VCW 4,5 t	4 500	0 - 25
	VEUW 4,5 t	4 500	0 - 45		VCEW 4,5 t	4 500	0 - 45
	VUW 6 t	6 000	0 - 32		VCW 6 t	6 000	0 - 32
	VEUW 6 t	6 000	0 - 50		VCEW 6 t	6 000	0 - 50
	VUW 7,5 t	7 500	0 - 40		VCW 7,5 t	7 500	0 - 40
	VEUW 7,5 t	7 500	0 - 55		VCEW 7,5 t	7 500	0 - 55
	VUW 9 t	9 000	0 - 55		VCW 9 t	9 000	0 - 55
	VUW 12 t	12 000	0 - 52		VCW 12 t	12 000	0 - 52
	VUW 15 t	15 000	0 - 76		VCW 15 t	15 000	0 - 76
	VUW 17 t	17 000	0 - 76		VCW 17 t	17 000	0 - 76
	VUW 20 t	20 000	0 - 80		VCW 20 t	20 000	0 - 80
	VUW 25 t	25 000	5 - 85		VCW 25 t	25 000	5 - 85
	VUW 30 t	30 000	10 - 90		VCW 30 t	30 000	10 - 90
	SVUW 6 t	6 000	40 - 90		SVCW 6 t	6 000	40 - 90
	SVUW 7,5	7 500	50 - 100		SVCW 7,5 t	7 500	50 - 100
	SVUW 9 t	9 000	50 - 100		SVCW 9 t	9 000	50 - 100
	SVUW 12 t	12 000	50 - 100		SVCW 12 t	12 000	50 - 100
SVUW 15 t	15 000	80 - 150	SVCW 15 t	15 000	80 - 150		
SVUW 20 t	20 000	80 - 150	SVCW 20 t	20 000	80 - 150		
SVUW 25 t	25 000	80 - 150	SVCW 25 t	25 000	80 - 150		
SVUW 30 t	30 000	80 - 150	SVCW 30 t	30 000	80 - 150		
VMPW / VEMPW / SVMPW	Označenie	Nosnosť (kg)	Rozsah čelustí (mm)	VEUW-A	Označenie	Nosnosť (kg)	Rozsah čelustí (mm)
	VMPW 0,75 t	750	0 - 13	<p>Rozsah čelustí</p> <p>0 až 95 mm</p> <p>nastaviteľný po 30 mm</p> 	VEUW-A 3 t	3 000	0 - 95
	VEMPW 1 t	1 000	0 - 25				
	VEMPW 2 t	2 000	0 - 35				
	VEMPW 3 t	3 000	0 - 35				
	VMPW 4,5 t	4 500	0 - 25				
	VEMPW 4,5 t	4 500	0 - 45				
	VMPW 6 t	6 000	0 - 32				
	VEMPW 6 t	6 000	0 - 50				
	VMPW 7,5 t	7 500	0 - 40				
	VEMPW 7,5 t	7 500	0 - 55				
	VMPW 9 t	9 000	0 - 55				
	SVMPW 6 t	6 000	40 - 90				
	SVMPW 7,5 t	7 500	50 - 100				
	SVMPW 9 t	9 000	50 - 100				

Zdvíhacie zvierky

Vertikálne



VUW-R Určená pre manipuláciu s nerezovými plechmi.	Označenie	Nosnosť (kg)	Rozsah čelustí (mm)	VHPUW	Označenie	Nosnosť (kg)	Rozsah čelustí (mm)	
Zvierka má nerezové čeluste.	VUW - R 2 t	2 000	0 - 20	Určená hlavne na zdvíhanie holandských profilov.	VHPUW 3 t	3 000	0 - 35	
					VHPUW 5 t	5 000	0 - 45	
VHPW	Označenie	Nosnosť (kg)	Rozsah čelustí (mm)	VNMW / VSNMW s plochými čelustami bez poškodenia povrchu.	Označenie	Nosnosť (kg)	Rozsah čelustí (mm)	
Na zdvíhanie holandských profilov.	VHPW 1 t	1 000	0 - 80		VNMW 0,5 t	500	1 - 20	
	VHPW 1,5 t	1 500	0 - 80		VSNMW 0,5 t	500	17 - 37	
	VHPW-A 1,5 t	1 500	0 - 155		VNMW 1 t	1 000	1 - 30	
			VNMW 1,5 t		1 500	1 - 40		
			VNMW 2 t		2 000	1 - 50		
			VNMW 3 t		3 000	1 - 60		
VNMAW s plochými čelustami bez poškodenia povrchu.	Označenie	Nosnosť (kg)	Rozsah čelustí (mm)	VJPW špeciálna pohyblivá čelusť pre dodatočný tlak .	Označenie	Nosnosť (kg)	Rozsah čelustí (mm)	
	VNMAW 0,5 t	500	1 - 180		VJPW 0,25 t	250	0 - 13	
					VJPUW 0,25 t	250	0 - 13	
BKW na prepravu a otáčanie oceľových nosníkov.	Označenie	Nosnosť (kg)	Rozsah čelustí (mm)	OBKW na zdvíhanie a prepravu oceľových nosníkov z boku.	Označenie	Nosnosť (kg)	Rozsah čelustí (mm)	
	BKW 1 t	1 000	0 - 15		OBKW 2 t	2 000	3 - 20	
	BKW 1,5 t	1 500	0 - 20					
	BKW 3 t	3 000	0 - 25					

Zdvíhacie zvierky

Vertikálne / Horizontálne



VUW-H / VEUW-H Pre tvrdé materiály.	Označenie	Nosnosť (kg)	Rozsah čelustí (mm)	VCW-H / VCEW-H Pre tvrdé materiály.	Označenie	Nosnosť (kg)	Rozsah čelustí (mm)
<p>Vybavená špeciálnymi čelustami pre materiál s povrchovou tvrdosťou až do 50 HRC</p> 	VUW-H 0,75 t	750	0 - 13	<p>Vybavená špeciálnymi čelustami pre materiál s povrchovou tvrdosťou až do 50 HRC</p> 	VCW-H 0,75 t	750	0 - 13
	VEUW-H 1 t	1 000	0 - 25		VCEW-H 1 t	1 000	0 - 25
	VEUW-H 2 t	2 000	0 - 35		VCEW-H 2 t	2 000	0 - 35
	VEUW-H 3 t	3 000	0 - 35		VCEW-H 3 t	3 000	0 - 35
	VEUW-H 4,5 t	4 500	0 - 45		VCEW-H 4,5 t	4 500	0 - 45
	VUW-H 6 t	6 000	0 - 40		VCW-H 6 t	6 000	0 - 32
	VEUW-H 7,5 t	7 500	0 - 55		VCEW-H 7,5 t	7 500	0 - 55
VMPW - H / VEMPW-H Pre tvrdé materiály.	Označenie	Nosnosť (kg)	Rozsah čelustí (mm)	HXW / HSXW	Označenie	Nosnosť (kg)	Rozsah čelustí (mm)
<p>Vybavená špeciálnymi čelustami pre materiál s povrchovou tvrdosťou až do 50 HRC</p> 	VMPW-H 0,75 t	750	0 - 13		HXW 1 t	1 000	0 - 35
	VEMPW-H 1 t	1 000	0 - 25		HXW 2 t	2 000	0 - 60
	VEMPW-H 2 t	2 000	0 - 35		HXW 3 t	3 000	0 - 60
	VEMPW-H 3 t	3 000	0 - 35		HXW 4 t	4 000	0 - 60
	VEMPW-H 4,5 t	4 500	0 - 45		HXW 6 t	6 000	0 - 60
	VMPW-H 6 t	6 000	0 - 32		HXW 8 t	8 000	0 - 60
	VEMPW-H 7,5 t	7 500	0 - 55		HXW 10 t	10 000	0 - 60
					HXW 12 t	12 000	0 - 60
					HSXW 2 t	2 000	0 - 100
					HSXW 3 t	3 000	0 - 100
					HSXW 4 t	4 000	0 - 100
					HSXW 6 t	6 000	0 - 100
					HSXW 8 t	8 000	0 - 100
					HSXW 10 t	10 000	0 - 100
				HSXW 12 t	12 000	0 - 100	
				HSXW 15	15 000	0 - 150	
DHW pre zdvíhanie a prepravu prehýbajúcich plechov	Označenie	Nosnosť (kg)	Rozsah čelustí (mm)	HXW - V vybavená prítlačnou spružinou	Označenie	Nosnosť (kg)	Rozsah čelustí (mm)
	DHW 1 t	1 000	0 - 15		HXW-V 1 t	1 000	0 - 35
	DHW 2 t	2 000	0 - 35		HXW-V 2 t	2 000	0 - 60
	DHW 4 t	4 000	0 - 50		HXW-V 3 t	3 000	0 - 60
	DHW 6 t	6 000	0 - 50		HXW-V 4 t	4 000	0 - 60
						HXW-V 6 t	6 000

Zdvíhacie zvierky

Špeciálne na sudy - skruže - rúry



VKFW zvierka na prepravu sudov	Označenie	Nosnosť (kg)	Rozsah čelustí (mm)	VKHW zvierka na prepravu sudov	Označenie	Nosnosť (kg)	Rozsah čelustí (mm)	
	VKFW 0,5 t	500	0 - 17		VKHW 0,6 t	600		
VSHW zvierka na prepravu sudov v horizontálnej polohe	Označenie	Nosnosť (kg)	Rozsah čelustí (mm)	BCW / BCW-A zvierky na skruže vo vertikálnej polohe	Označenie	Nosnosť (kg)	Rozsah čelustí (mm)	
	VSHW 0,6 t	600	500 - 900		BCW 1 t	1 000	60 - 120	
					BCW-A 1t	1 000	50 - 220	
						BCW-A		
PHW / PHW-HD hákové zvierky na prepravu trubiek a rúr.	Označenie	Nosnosť (kg)	Max. hrúbka steny (mm)	BCW 1t / 3 ks + reťaz	BCW 1t / 3 ks + reťaz	2500 kg	60-120	
 	PHW 1,5 t	1 500	40	 				
	PHW 3 t	3 000	40					
	PHW 4 t	4 000	50					
	PHW 6 t	6 000	50					
	PHW 8 t	8 000	70					
	PHW 10 t	10 000	70					
	PHW 12 t	12 000	70					
	PHW 15 t	15 000	70					
	PHW 20 t	20 000	70					
	PHW-HD 5 t	5 000	60					
	PHW-HD 10 t	10 000	60					
	PHW-HD 20 t	20 000	60					
	PHW-HD 30 t	30 000	60					
PHW-HD 60 t	60 000	60						
TLW zvierka na prepravu trubiek a kruhových profilov	Označenie	Nosnosť (kg)	Zverná šírka Ø (mm)	BLCW čeluste vybavené polyuretánovou ochranou	Označenie	Nosnosť (kg)	Rozsah čelustí (mm)	
	TLW 0,5 t	500	48,3-114,3		BLCW 0,5 t	500	30 - 110	
	TLW 1 t	1 000	114,3-219,1		BLCW 1 t	1 000	100 - 230	
	TLW 2 t	2 000	219,1-368		BLCW 2 t	2 000	220 - 360	
	TLW 3 t	3 000	368-508		BLCW 3 t	3 000	350 - 500	

Zdvíhacie zvierky

Zvierky na skruže / stohovacie háky / traverzy

BTG zvierky na skruže sada (3 kusy + reťaze)	Označenie	Nosnosť (kg)	Rozsah čelústí (mm)	BVH stohovacie háky	Označenie	Nosnosť (kg) 1 ks	B (mm)
	BTG 1,5/120	1 500	40 - 120	 	BVH 0,5	500	50
	BTG 3 / 180 TM-N	3 000	50 - 180		BVH 1,12	1 120	60
	BTG 3 / 220 TM-N	3 000	90 - 220		BVH 1,5	1 500	70
					BVH 2	2 000	80
					BVH 2,5	2 500	100
					BVH 3,2	3 200	120
					BVH 4	4 000	160
					BVH 5	5 000	200
					BVH 6	6 000	250
					BVH 7,5	7 500	300
GHW pewag stohovacie háky	Označenie	Nosnosť (kg) 1 ks	S (mm)	BWW pewag stohovacie háky		Nosnosť (kg) 1 ks	S (mm)
	GHW 5/6	1 400	100		BWW 7/8	2 500	80
	GHW 7/8	2 500	150		BWW 10	4 000	100
	GHW 10	4 000	200		BWW 13	6 700	130
					BWW 16	10 000	160
				BWW19 - 20	16 000	185	
				BWW 22	19 000	220	
TTS-E traverza				TTS traverza prestaviteľná			
							
Záves na vysokozdvížne vozíky							
TTS-Z záves pre vysokozdvížny vozík	Označenie	Nosnosť (kg)		TZH záves pre vysokozdvížny vozík	Označenie	Nosnosť (kg)	
	TTS 2,0 - Z	2 000			TZH1,5 /150	1 500	
	TTS 3,15 - Z	3 150			TZH 3 / 150	3 000	
	TTS 5,3 - Z	5 300			TZH 5/150	5 000	
					TZH 5/200	5 000	
					TZH 10/200	10 000	

Zdvíhacie zariadenia

Kladkostroje a navijáky - ručné - elektrické

Silverline HZ S	Model	Nosnosť (kg)	Počet prameňov nosnej reťaze	Yalehandy / UNOplus	Model	Nosnosť (kg)	Počet prameňov nosnej reťaze
	HZ S 750	750	1		Yalehandy 250	250	1
	HZ S 1500	1 500	1		Yalehandy 500	500	1
	HZ S 3000	3 000	1				
	HZ S 6000	6 000	2		UNOplus 750	750	1
					UNOplus 1500	1 500	1
					UNOplus 3000	3 000	1
					UNOplus 6000	6 000	2
Lanový zdvihák Yaletrac	Model	Nosnosť (kg)	Dĺžka lana (m)	Lanový zdvihák LM	Model	Ťahová sila (daN)	
	Y 08	800	20			bez kladky	s kladkou
	Y 16	1 600	20		115 DV-B	500	1 000
	Y 32	3 200	20		202 WN-VB	500	1 000
					434 WN-VB	500	1 000
					S 434 WN-VB	700	1 400
					S 404 WN-VB	900	1 800
Hrebeňový zdvihák	Model	Nosnosť (kg)		Ručné / elektrické navijáky- kladkostroje			
	SJ 15	1 500					
	SJ 30	3 000					
	SJ 50	5 000					
	SJ 100	10 000					

Viac na www.jovatrade.sk

Bremenové magnety

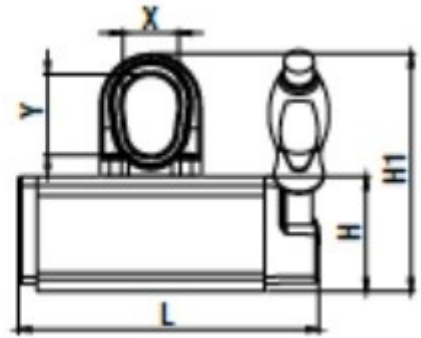
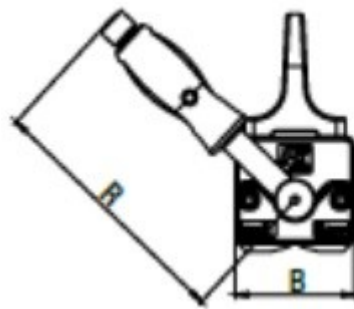

Typ	Nosnosť / materiál		Max. nosnosť od hrúbky materiálu (mm)	Rozmery (mm)						Váha (kg)
	Plochý	Kruhový		L	B	H	H1	R	X/Y	
FX -150	150 kg	Ø50-200mm 75 kg	8	161	64	60	124	136	30/42	3,6
FX -300	300 kg	Ø50-300mm 150 kg	15	205	87	78	158	190	42/53	8,4
FX -600	600 kg	Ø80-400mm 300 kg	20	288	112	94	189	228	51/62	19
FX -1000	1000 kg	Ø100-450mm 500 kg	25	361	152	120	240	261	60/76	42
FX -2000	2000 kg	Ø120-600mm 1000 kg	50	472	228	169	313	409	68/89	115
FX -3000	3000 kg	Ø250-600mm 1500 kg	50	648	228	169	313	534	68/89	166

V ponuke aj špeciálne magnety viac na www.jovatrade.sk

Bremenové magnety



Vertikálne systémy



Pomocné traverzy



Závesné váhy / Bezpečnostné prostriedky na pracu vo výškach.

Závesné váhy a dynamometre

					
DTEN	DTER	OCSF	DTEZ	MCWN	MCW 09
Váživosť kg					
3 000	3 000	50	3 000	300	3 000
5 000	5 000	150	5 000	600	6 000
10 000		300	10 000	1 500	9 000
20 000			20 000	3 000	12 000
			30 000	6 000	17 000
				9 000	25 000
					30 000
					50 000

Bezpečnostné prostriedky na prácu vo výškach. (viac info. na www.jovatrade.sk)



Oceľové laná

Oceľové laná zalisované		nosnosti kg			
1 ramenné		2 ramenné		3 a 4 ramenné	
uhol sklonu β		β 0° - 45°	β 45° - 60°	β 0° - 45°	β 45° - 60°
Hrúbka lana	kg	kg	kg	kg	kg
6	330	450	330	690	500
8	600	800	600	1 250	880
9	750	1 000	750	1 550	1 100
10	900	1 250	900	1 900	1 350
11	1 100	1 500	1 100	2 300	1 650
12	1 350	1 850	1 350	2 750	1 950
14	1 800	2 500	1 800	3 800	2 700
16	2 400	3 300	2 400	5 000	3 500
18	3 000	4 200	3 000	6 300	4 500
20	3 700	5 200	3 700	7 800	5 500
22	4 500	6 300	4 500	9 500	6 700
24	5 400	7 500	5 400	11 200	7 900
26	6 300	8 700	6 300	13 200	9 300
28	7 300	10 200	7 300	15 000	10 800
30	8 200	11 700	8 200	17 000	12 500
32	9 500	13 500	9 500	19 500	14 000
34	10 800	15 000	10 800	22 500	16 000
36	12 000	16 500	12 000	25 000	18 000
38	14 000	18 500	14 000	28 000	20 000
40	15 000	20 500	15 000	31 000	22 000
42	16 500	22 500	16 500	34 000	24 500
44	18 000	24 500	18 000	37 000	26 500
46	20 000	27 000	20 000	41 000	29 000
48	22 000	29 500	22 000	44 500	31 500
50	23 000	32 000	23 000	48 500	34 500

V ponuke aj metráž oceľových lán rôznych konštrukcií.

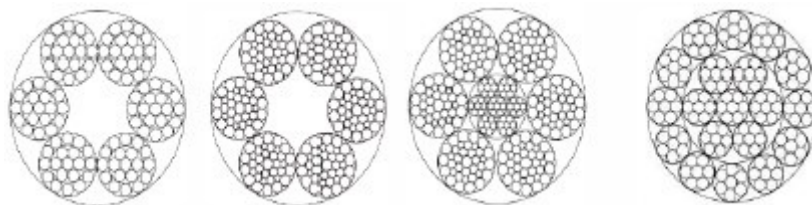



Laná a šnúry

Laná a šnúry

- PP polypropylénové
- PA polyamidové
- PES polyesterové
- konopné z prírodných materiálov



Permanentné bremenné magnety

Permanentné bremenné magnety

- FX LIFT
- TPM
- PML
- MaxX
- TML na plechy už od 2 mm hrúbky



Strmene

Strmene na zdvíhanie prenášanie a spájanie

- so skrutkou
- s maticou a závlačkou



Traverzy

Žeriavové traverzy

- pevná TTS-E
- prestaviteľná TTS
- pre skriňové palety TTS
- pre Big-Bag vrecia TTB



C-háky

Žeriavové vidly (eurozáves)

C-háky

- na prenášanie zvitkov TCK
- na prenášanie a sklápanie TCS

Žeriavové vidly

- automatické vyváženie TKG vhs
- manuálne vyváženie TKG vh



Žeriavové váhy

Závesné váhy

- snímače ťahovej sily
- s digitálnym displejom
- s rádiovým ovládaním



Snehové a ochranné reťaze

Snehové reťaze

- pre osobné autá
- pre autá SUV, 4X4 a dodávky
- pre autobusy a nákladné autá
- pre traktory, vysokozdvížne vozíky
- pre malotraktory a štvorkolky
- ochranné reťaze



Lesnícke reťaze pewag

Lesnícke reťaze

- trieda G8 a príslušenstvo
- trieda G10 a príslušenstvo



Ochranné reťaze

Ochranné reťaze

- Premium
- Professional
- Basic

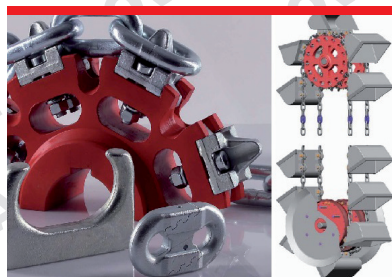

Korečkové elevátory a dopravníky

Reťaze a komponenty

- korečkové elevátory
- dopravníky

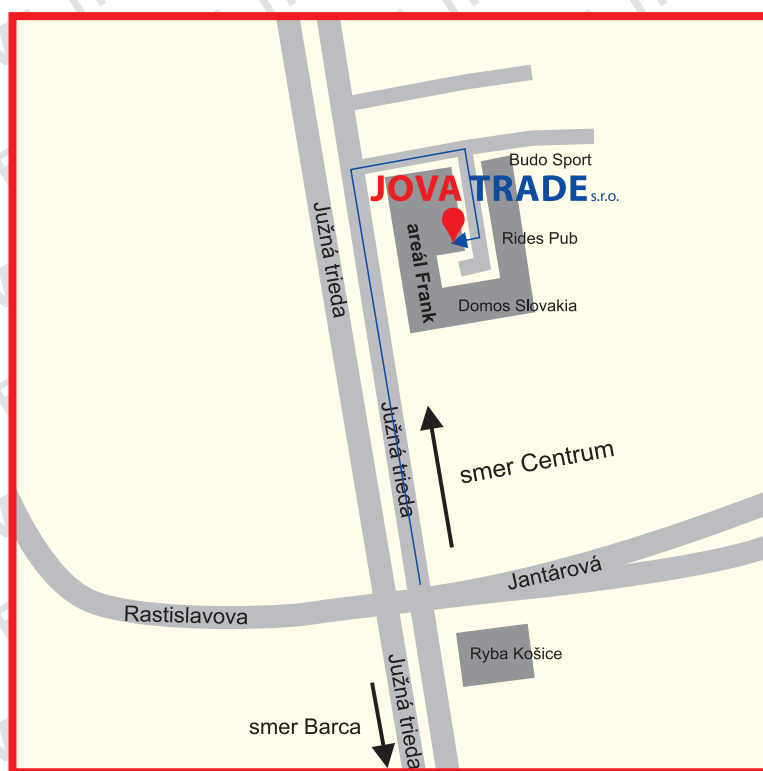

JOVA TRADE s.r.o.

viazacie prostriedky | zdvíhacia technika

Južná trieda 48, 040 01 Košice

areál Frank

mobil: 0910 981 041

e - mail: obchod@jovatrade.sk

www.jovatrade.sk